

100% Defence Oriented Unit

Vijay Engineers

Manufacturer of :- Indigenisation of Precision Products/ Assemblies/ Sub-assemblies, Design & Manufacturing of Special Purpose Machines, Automations with Precision Part & Fabrication for Indian Ordnance Factories, DRDO, Indian Navy, Army & Airforce.



INTRODUCTION

We, M/s Vijay Engineers have been in the business of Engineering Equipment, design, Manufacturing & Indigenising for various Defence Units all over India. we are equipped with the best Team that is committed to accomplish the given task without compromising on quality in-time. We have Manufactured and supplied Special Purpose Machines as per requirement to Defense Divisions and have received Appreciation from Ministry of Defense. We have a well-established track record we have achieved customer satisfaction consistently. With quality manufacturing facilities and skilled workforce, we have been dealing in all kinds of machinery including critical parts for processing line machine.

OUR ACHIEVEMENTS

- 1) Appreciation from CNAI(W) Indian Navy for the indigenisation of signal flare launcher basket for KALVARI submarine.
- 2) Appreciation from “Indian Economic Development & Research Association” New Delhi.
- 3) Appreciated for Development of Vital Import Substitute for Conveyor Transfer Bar Assembly 5.56 mm Bullet by Ammunition Factory Khadki – Pune.
- 4) Ordnance Factory Ambajhari were given the task to build a light weight KM bridge for the Indian Army, for which we have fulfilled the requirement of Joint Bands, Roller Launching, CSK fitted Assembly to Bridge shop for the development of Sub Assembly. Because of which we have been presented an Appreciation Letter by OFAJ.





APPRECIATION LETTERS FROM DEFENCE FACTORIES

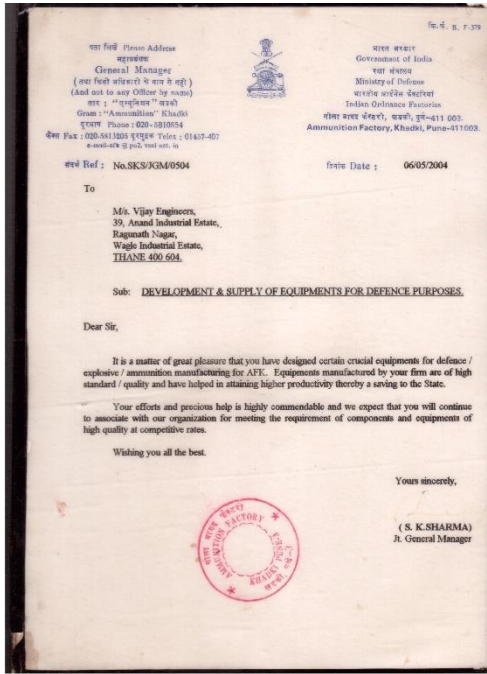

APPRECIATION LETTER FOR DEVELOPMENT OF CRUCIAL EQUIPMENT FOR DEFENCE PURPOSE FROM AFK.

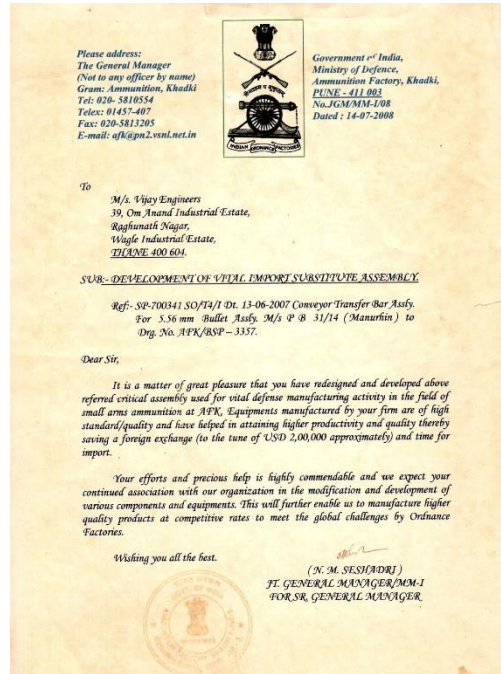

APPRECIATION LETTER FOR CONVEYOR TRANSFER BAR ASSEMBLY FOR 5.56MM BULLET ASSEMBLY FROM AFK.

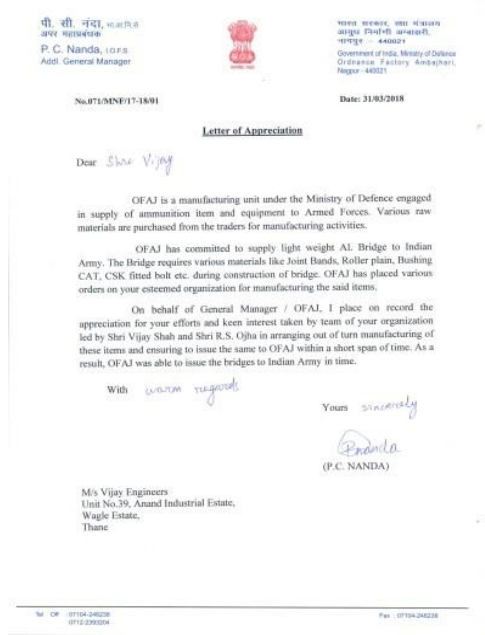

APPRECIATION LETTER FOR LIGHT WEIGHT ALUMINIUM BRIDGE TO INDIAN ARMY FROM OFAJ.

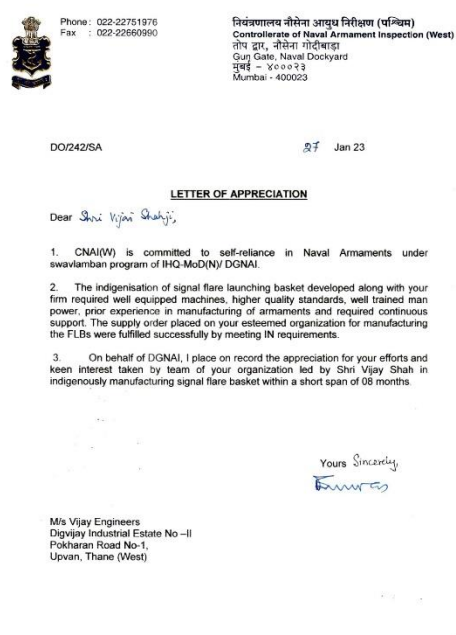

APPRECIATION LETTER FOR INDIGENISATION OF SIGNAL FLARE LAUNCHER BASKET FOR KALVARI SUBMARINE FROM CNAI(W), INDIAN NAVY.



BUSINESS DETAILS

Name of the Company: Vijay Engineers

Address: Sainath Industrial Estate No. 02, Pokhran Road No – 01, Upvan, Thane (W) – 400606.

Contact No: 1) 9821402759 --- Mr. Vijay Shah (Proprietor).

2) 9702948485 ----Mr. Ravindra Oza (Marketing Head).

E-Mail ID: vijayengmumbai@yahoo.co.in

Website: www.vijayengineers.net

Year of Establishment: 1994

Constitution: Proprietor

Our GST Details: 27ACDPS5522L1ZA

We are registered with MSME, NSIC, SIDM, SAMAR Level 4, DRDO (HEMRL), AS 9100, NCAGE, NCAGE+, 506 Army Base Workshop, Jabalpur, ISO 9001 Certifications and under the Make in India initiative we are ZED Silver Certified Unit. We are also Certified by Quality Council of India.

All our raw material tests are carried out by NABL Accredited Laboratories. Each and every instrument is well calibrated at regular intervals.

We are also having In-house Heat Treatment facilities:

- 1) Muffle Furnace of Capacity – 400°C To 1150°C
- 2) Hot Air Oven of Capacity -- 0°C To 300°C



OUR CERTIFICATION

भारत सरकार
Government of India
सूक्ष्म, लघु एवं मध्यम उद्यम विभाग
Ministry of Micro, Small and Medium Enterprises

**UDYAM
REGISTRATION CERTIFICATE**

Our small hands to make you LARGE

UDYAM REGISTRATION NUMBER	UDYAM MH 55 005944
NAME OF ENTERPRISE	VIJAY ENGINEERS
TYPE OF ENTERPRISE	MSME (MSME (MSME) Form 1)
MAJOR ACTIVITY	MANUFACTURING
SOCIAL CATEGORY OF ENTREPRENEUR	GENERAL
NAME OF UNIT(S)	Unit Name: Name of Estate
OFFICE ADDRESS OF ENTERPRISE	Plot No. 10, Divijay Industrial Estate, POKHARAN ROAD NO. 1, UPVAN, THANE (WEST), MAHARASHTRA - 400606
DATE OF INCORPORATION/REGISTRATION OF ENTERPRISE	12/09/2022
DATE OF COMMENCEMENT OF PRODUCTION	12/09/2022
NATIONAL SERVICE (CLASSIFICATION CODES)	1. MSME (MSME) Form 1 2. MSME (MSME) Form 2
DATE OF UDYAM REGISTRATION	12/02/2022

For any assistance, you may contact:
1. District Industries Centre: THANE (MAHARASHTRA)
2. MSME (DI): THANE (MAHARASHTRA)

BE A CHAMPION with the Ministry of MSME

UDYAM REGISTRATION CERTIFICATE

UCS-UK

Certificate of Registration

This is to certify that
VIJAY ENGINEERS
OFFICE & FACTORY ADDRESS: DIVIJAY INDUSTRIAL ESTATE-II, POKHARAN ROAD 1 UPVAN, THANE (WEST)-400606, MAHARASHTRA, INDIA.

Has been assessed and found in as per ISO 9001:2015 compliance to the requirement of standard details below.

ISO 9001:2015
(QUALITY MANAGEMENT SYSTEM)

For The Following Scope Of Activities:
MANUFACTURES OF LOAD CELLS, PRECISION MACHINING, SHEET METAL PARTS, RECONDITIONING, DESIGNING AND AUTOMATION OF MECHANICAL, ELECTRICAL AND ELECTRONIC EQUIPMENTS FOR DEFENCE INDUSTRIES.

This certificate is property of Unitas Certification Services & remains valid subject to satisfactory surveillance audits.

Certificate No: 124839
Surveillance Date: 28-FEB-2025

Registration Date: 31-MAR-2022
Certificate Expiry: 06-MAR-2025

Chairman
Unitas Certification Services

The certificate is valid as long the organization's meet unitas certification services's requirements.
The status of the certificate may be checked at www.unitascertification.com
UNITAS CERTIFICATION SERVICES
Head Office: 54 Emerald Close, Lake, Luton, Bedfordshire, MK12 3DU-UK
website: www.unitascertification.com / Email: info@unitascertification.com

ISO 9001:2015 REGISTRATION CERTIFICATE

राष्ट्रीय लघु उद्योग निगम लिमिटेड
THE NATIONAL SMALL INDUSTRIES CORPORATION LIMITED
(A Government of India Enterprise)

Branch Office 3910A, Khairasa MIDC, TTC Industrial Area, Koperkhairasa, Near Mumbai-400710
Ph: 922-2762085 Fax: 922-27634989
Website: www.nsiconline.com

GOVERNMENT PURCHASE ENLISTMENT CERTIFICATE

Renewal Certificate (Valid From 23/02/2022 to 22/02/2024) Date: 23/03/2022
Ref.No: NSIC/MG/PUR/RSV-188008

MR. VIJAY ENGINEERS
DIVIJAY INDUSTRIAL ESTATE NO. II, POKHARAN ROAD NO. 1, UPVAN, THANE (WEST), THANE, MAHARASHTRA - 400606

Name of the Proprietor: MR. VIJAY K. SHAIKH
Constitution: Udyam Registration Enterprise Social Class: Special Category: Proprietorship Number: UDYAM-MS-25-GENERAL-005944

GOVERNMENT PURCHASE REGISTRATION NO: NSIC/GP/MUM/2016/0020752
Monetary Limit: ₹ 50 Lakh / 7 Crore Lakh Only
TURNOVER (Rupees in Lakhs)

Financial Year	Annual Turnover
2018-19	169.45
2019-20	67.59
2020-21	86.12
Monetary Limit	50

MSEs registered with NSIC are exempted from deposit of Earnest Money irrespective of value of Monetary Limit.

Your name has been registered as a MSE Unit eligible for participation in the Central Government Store Purchase Programme as per the Single Point Registration Scheme for the following items/store (s)(Service/s)

Name of the Store(s)/ Service(s)	Specification(s)	Qualitative Capacity	Quantitative Capacity P.A.
As per List Attached (72 Item only)			

MIS VIJAY ENGINEERS
Authorized Signatory

NSIC REGISTRATION CERTIFICATE

UCS-UK

Certificate of Compliance

This is to certify that
VIJAY ENGINEERS
REGISTERED ADDRESS: DIVIJAY INDUSTRIAL ESTATE NO-2, POKHARAN ROAD NO-01, UPVAN, THANE-400606, MAHARASHTRA, INDIA.

Has been assessed and found in as per AS 9100:2016(D) compliance to the requirement of standard details below.

AS 9100:2016 (D)
(Aerospace Quality Management Systems)

For The Following Scope Of Activities:
MANUFACTURING OF PRECISION PARTS, LOAD CELLS, DEFENCE COMPONENTS, SPM'S & AUTOMATION.

This certificate is property of Unitas Certification Services & remains valid subject to satisfactory surveillance audits.

Certificate No: 9001548
Surveillance Date: 05-MAR-2024

Registration Date: 06-APR-2023
Certificate Expiry: 05-MAR-2026

Chairman
Unitas Certification Services

The certificate is valid as long the organization's meet unitas certification services's requirements.
The status of the certificate may be checked at www.unitascertification.com
UNITAS CERTIFICATION SERVICES
Head Office: 54 Emerald Close, Lake, Luton, Bedfordshire, MK12 3DU-UK

AS 9100:2016 REGISTRATION CERTIFICATE



OUR CERTIFICATION



SAMAR LEVEL 4 CERTIFICATE



ZED SILVER CERTIFICATE



506 ARMY BASE WORKSHOP,
JABALPUR REGISTRATION
CERTIFICATE



MSME WASH CERTIFICATE



OUR CERTIFICATION



REGISTERED WITH HEMRL DRDO
Unique Registration No. /2023/00059



NCAGE Code:- 7173Y | NCAGE+ Code: 22CYMH

NCAGE & NCAGE + REGISTRATION CODE



MEMBER OF SIDM
MEMBERSHIP NO. PM-2023-0765



MEMBER OF BRIDGE BHARAT COUNCIL
MEMBERSHIP NO. BBC/M/10/2024



LIST OF FEW SPM MACHINES SUPPLIED TO DEFENSE DIVISIONS:

1. Two Head Liner Weighing Machine – Ordnance factory Bhandara.
2. Salt Spray Apparatus – Ammunition factory Khadki, Pune.
3. Integration Trolley - Ordnance factory Ambajhari, Nagpur.
4. Caulking Equipment – Machine Tool Prototype factory, Ambernath.
5. Centre of Gravity Measuring Machine – Ordnance factory Muradnagar/Ordnance factory Khamaria, Jabalpur.
6. Critical Stores/Assemblies developed for Dhanush Gun for Gun Carriage factory, Jabalpur.
7. Vacuum Cleaning Machine for cleaning of PINAKA POD 5.5 meters long at Ordnance factory Chanda, Chandrapur.
8. Supply of Painting Booth Assembly for painting of Shell body of Pinaka Missiles to Ordnance factory Chanda, Chandrapur.
9. Manufacturing & Supply of Primer Electric 1AL full body Assembly to Ordnance factory Chanda, Chandrapur.
10. Design Supply Installation & Commissioning of Single Base Propellant Filling Machine Accuracy - $\pm 29\text{m}$ to Ordnance Factory Nalanda, Bihar.
11. Supply Erection & Commissioning of Crimping Machine For Detonator 356MG ZL to Ordnance Factory Badmal, Bolangir, Orissa.
12. Water tube (Horizontal) tester for DRDO (HEMRL), Pune.

My Company, my team is fully committed to complete the given task without compromising on quality. We have been consistently Manufacturing for Ordnance factories all over India since 1994. We are undergoing business developments and we are constantly evolving to make sure that we meet our customers' requirements. We have always maintained a positive approach in our work and it has always been our strength.

We are looking forward to the Make in India initiative for Defense Industries, we can offer optimum quality products in timely delivery with more investment if we get good order assurance for long term business.

Mr. Vijay Shah
Proprietor

OUR PRODUCTS & CUSTOMERS

INDIAN NAVY

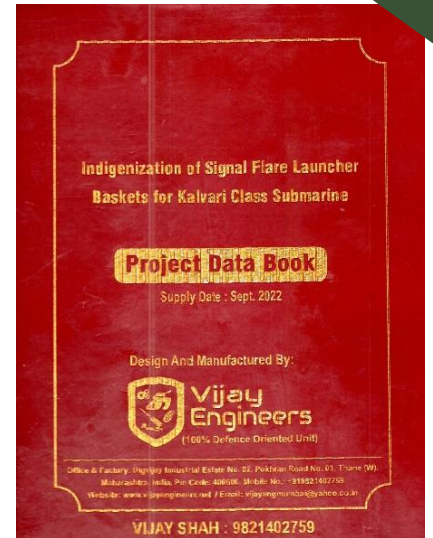
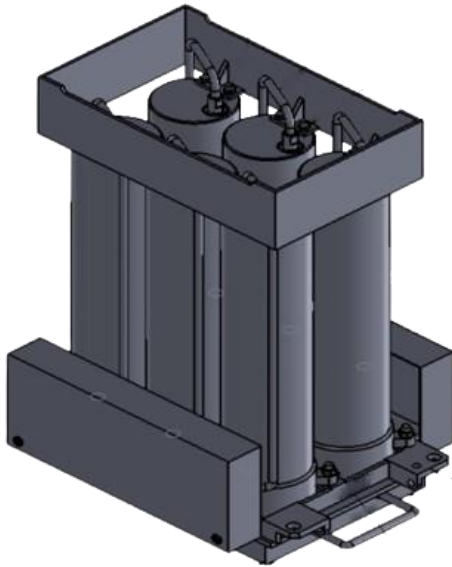

INDIGENISATION OF SIGNAL FLARE LAUNCHER BASKETS FOR KALVARI CLASS SUBMARINE

Controller of Naval Armament Inspection (West),



INDIGENISATION OF BOLLARD TEST 71ME

Naval Armament Inspectorate, Karanja

DEVELOPMENT OF LONG LIFE BALLOON

Naval Armament Inspectorate, Karanja



OUR PRODUCTS & CUSTOMERS

MUNITIONS INDIA LIMITED



**Crimping Machine for Detonator
365 MG LZ**
Ordnance factory Bolangir, Badmal



Vacuum Cleaning Machine
For Pinaka POD Cleaning
Ordnance factory Chanda, Chandrapur



ADAPTOR NOSE
Ordnance factory Chanda, Chandrapur



TRANSPORT JAR
Ordnance factory Bhandara



CONVEYORS
Ordnance factory Varangaon



FILLING & SEALING MACHINE
Ordnance factory Khamaria, Jabalpur



OUR PRODUCTS & CUSTOMERS

MUNITIONS INDIA LIMITED



BASE PLUG

Ammunition factory Khadki, Pune

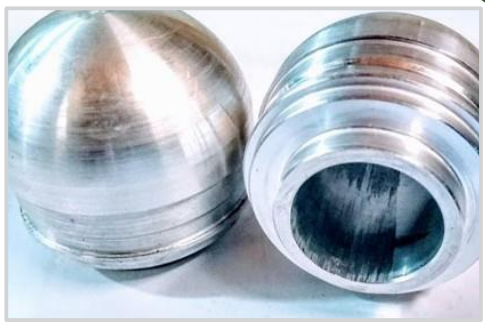

MODIFIED PRF

Ammunition factory Khadki, Pune



TWO HEAD LINER WEIGHING MACHINE

Ordnance factory Bhandara



CENTER OF GRAVITY MARKING & MEASURING MACHINE FOR AERIAL BOMB (250KG & 450KG) AND 1000 LB

Ordnance factory Khamaria
Ordnance factory Muradnagar



FIRE HOLE DRILLING MACHINE

Ammunition factory Khadki, Pune



VITAL DEFENCE SPARES



OUR PRODUCTS & CUSTOMERS

MUNITIONS INDIA LIMITED



PRIMER ELECTRIC 1 AL
Ordnance factory Chanda, Chandrapur



VACUUM TESTING EQUIPMENT
Ordnance factory Khamaria, Jabalpur



PICK AND PLACE MACHINE
Ordnance factory Khamaria, Jabalpur



PALLET TRUCK
Ammunition factory Khadki, Pune



FIRE TRANSMITTING TUBE
Ordnance Factory Chanda

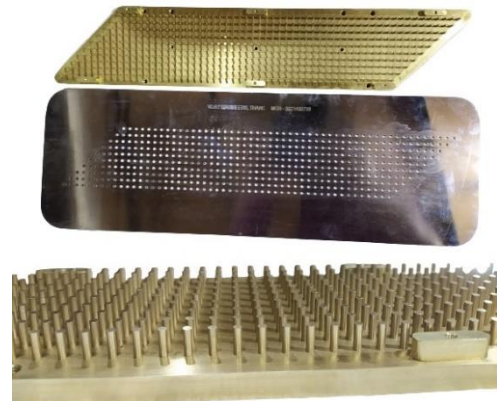

Knock Out Plate Assembly
Ammunition Factory Khadki



OUR PRODUCTS & CUSTOMERS

YANTRA INDIA LIMITED

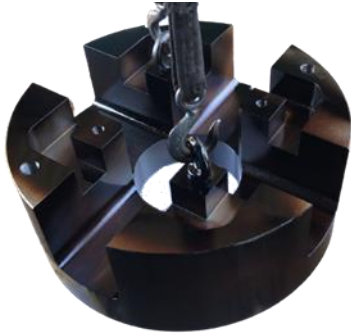

ROLLER HOUSING
Ordnance factory Ambajhari



LOCKING LEVER
Ordnance factory Ambajhari



ANCHOR STOCK
Ordnance factory Ambajhari



LOCKING BOLT
Ordnance factory Ambajhari



ADAPTOR PIERCER
Ordnance factory Katni



**HEAT SEALER FOR
PVC BAGS**
Ordnance factory Ambarnath



OUR PRODUCTS & CUSTOMERS

ADVANCED WEAPONS AND EQUIPMENT INDIA LIMITED



HAND PUMP WITH ASSY
Gun Carriage Factory, Jabalpur



GREASE GUN ASSY
Gun Carriage Factory, Jabalpur



HANDLE LEFT RIGHT
Gun Carriage Factory, Jabalpur



TOWING EYE
Gun Carriage Factory, Jabalpur



**DEVELOPMENT OF GABLE
(INVESTMENT CASTING)
BY 3D PRINTING**
Gun Carriage Factory, Jabalpur



RAMMER HEAD
Gun Carriage Factory, Jabalpur

OUR PRODUCTS & CUSTOMERS
ADVANCED WEAPONS AND EQUIPMENT INDIA
LIMITED



BRACKET LEFT
INVESTMENT CASTING
Gun Carriage Factory, Jabalpur



BRACKET
Gun Carriage Factory, Jabalpur

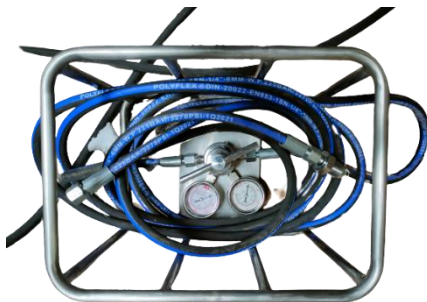

GAS FILLING UNIT
Gun Carriage Factory, Jabalpur



TRIAL SPADE CASTING
Gun Carriage Factory, Jabalpur



LOWER & UPPER COVER
Gun Carriage Factory, Jabalpur

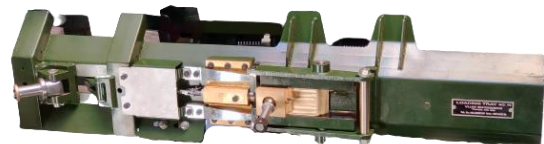

LOADING TRAY FOR
BOFORS/ DHANUSH GUN
Gun Carriage Factory, Jabalpur



OUR PRODUCTS & CUSTOMERS ADVANCED WEAPONS AND EQUIPMENT INDIA LIMITED



**DEVELOPMENT OF
BEARING HOUSING
(INVESTMENT CASTING)**
Gun Carriage Factory, Jabalpur



RELIEVING TOOL ASSY
Gun Carriage Factory, Jabalpur



BUFFER ASSEMBLY
Gun Carriage Factory, Jabalpur



**OUTER CASE LEFT AND
RIGHT ASSEMBLY**
Gun Carriage Factory, Jabalpur



**DEVELOPMENT OF
HOUSING LEFT
(INVESTMENT CASTING)**
Gun Carriage Factory, Jabalpur



Anvil Plate Assembly
Ordnance Factory Varangaon

OUR PRODUCTS & CUSTOMERS

ARMOURED VEHICLES NIGAM LIMITED



DRUM PRESSURE ASSY
Heavy Vehicles Factory, Avadi



DRIVE GEAR
Heavy Vehicles Factory, Avadi



CAULKING EQUIPMENT
Machine tool prototype factory,
Ambernath



IGB STAND
Machine tool prototype factory,
Ambernath



AZIMUTH INDICATOR
Machine tool prototype factory,
Ambernath



**HYDRAULIC COUPLING WITH
SHAFT ASSY**
Machine Tool Prototype Factory,
Ambernath



OUR PRODUCTS & CUSTOMERS DRDO (HEMRL)



WATER TUBE (HORIZONTAL) TESTER
DRDO (HEMRL), Pune

OUR PRODUCTS & CUSTOMERS YANTRA INDIA LIMITED



**INTEGRATION TROLLEY FOR ASSEMBLY OF PINAKA
WARHEAD & PROPULSION UNIT & DISMANTLING OF
PINAKA ROCKET**
Ordnance factory Ambajhari, Nagpur

OUR PRODUCTS & CUSTOMERS

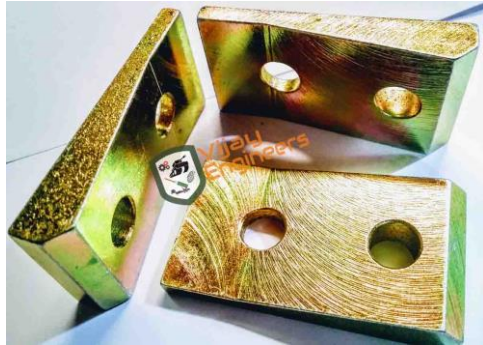

JOINT BAND
Ordnance factory Ambajhari



Salt Spray Apparatus

SALT SPRAY APPARATUS
Ammunition factory Khadki



Progressive tool for Engaging plate

PROGRESSIVE TOOL FOR ENGAGING PLATE
Ordnance factory Bhandara



LIP POURING LADLE - 750 KGS

350 KG LIP POURING CABLE
Grey Iron Factory, Jabalpur



FILLING & SEALING EQUIPMENT
FOR PKG OF 7.62 MM HD AMMN IN POLY BAG

Filling & Sealing Equipment
Ordnance factory Khamaria



Foot Valve
Gun Carriage Factory, Jabalpur



100% Defence Oriented Unit

Vijay Engineers

Manufacturer of :- Indigenisation of Precision Products/ Assemblies/ Sub-assemblies, Design & Manufacturing of Special Purpose Machines, Automations with Precision Part & Fabrication for Indian Ordnance Factories, DRDO, Indian Navy, Army & Airforce.

 Plot no. 02, Sainath Industrial Estate, Pokhran Road No. 01, Upvan, Thane (w), Maharashtra, India. Pin code:- 400606.

 +91-9821402759  www.vijayengineers.net

 vijayengmumbai@yahoo.co.in